



NEW HAVEN PUBLIC SCHOOLS

Amended
BOARD OF EDUCATION MEETINGS
13 Month Calendar for 2020 - 2021

January	13, 2020 27, 2020
February	10, 2020 24, 2020
March	9, 2020 23, 2020
April	13, 2020 27, 2020
May	11, 2020 26, 2020 (Tuesday)*
June	8, 2020 22, 2020
July	13, 2020 27, 2020
August	10, 2020 24, 2020
September	14, 2020 28, 2020
October	13, 2020 (Tuesday)* 26, 2020
November	9, 2020 23, 2020
December	14, 2020
January	11, 2021 25, 2021

(*) Indicates meeting will be on Tuesday due to legal holiday on Monday.

PLEASE NOTE:

Board of Education meetings are held the second and fourth Monday of the month at **5:30 p.m.** in the Cafetorium of **King Robinson School**, 150 Fournier Street, New Haven, CT; unless otherwise indicated.



NEW HAVEN PUBLIC SCHOOLS

Amended
FINANCE AND OPERATIONS MEETINGS
13 Month Calendar for 2020 - 2021

January	7, 2020 (Tuesday)* 21, 2020 (Tuesday)*
February	3, 2020 18, 2020 (Tuesday)*
March	2, 2020 16, 2020
April	6, 2020 20, 2020
May	4, 2020 18, 2020
June	1, 2020 15, 2020
July	6, 2020 20, 2020
August	3, 2020 17, 2020
September	8, 2020 (Tuesday)* 21, 2020
October	5, 2020 19, 2020
November	2, 2020 16, 2020
December	7, 2020
January	4, 2021 19, 2021 (Tuesday)*

(*) Indicates meeting will be on Tuesday due to legal holiday on Monday.

PLEASE NOTE

Finance and Operations meetings are held the first and third Monday of the month at **4:30 p.m.** in the Second Floor Board Room, **Gateway Center**, 54 Meadow Street, New Haven, CT; unless otherwise indicated.



NEW HAVEN PUBLIC SCHOOLS

Amended
GOVERNANCE MEETINGS
13 Month Calendar for 2020 - 2021

January	7, 2020 (Tuesday)* 21, 2020 (Tuesday)*
February	3, 2020 18, 2020 (Tuesday)*
March	2, 2020 16, 2020
April	6, 2020 20, 2020
May	4, 2020 18, 2020
June	1, 2020 15, 2020
July	6, 2020 20, 2020
August	3, 2020 17, 2020
September	8, 2020 (Tuesday)* 21, 2020
October	5, 2020 19, 2020
November	2, 2020 16, 2020
December	7, 2020
January	4, 2021 19, 2021 (Tuesday)*

*Indicates meeting will be on Tuesday due to legal holiday on Monday.

Governance meetings are held the first and third Monday of the month at **5:30 p.m.** in the Administrative Offices, Third Floor Conference Room, **Gateway Center**, 54 Meadow Street, New Haven, CT; unless otherwise indicated.



NEW HAVEN PUBLIC SCHOOLS

Amended
TEACHING & LEARNING MEETINGS
13 Month Calendar for 2020 - 2021

January 15, 2020

February 12, 2020

March 18, 2020

April 22, 2020

May 20, 2020

June 17, 2020

July 15, 2020

August 19, 2020

September 16, 2020

October 21, 2020

November 18, 2020

December 16, 2020

January 20, 2021

Teaching & Learning meetings are held the third Wednesday of the month at **4:30 p.m.** in the Second Floor Board Room, **Gateway Center**, 54 Meadow Street, New Haven, CT; unless otherwise indicated.



NEW HAVEN PUBLIC SCHOOLS

**FACILITIES NAMING COMMITTEE
QUARTERLY MEETINGS
13 Month Calendar for 2020 - 2021**

April 16, 2020

July 16, 2020

October 15, 2020

January 21, 2021

PLEASE NOTE

Facilities Naming Committee meetings are held quarterly on the third Thursday of the appropriate month at **5:00 p.m.** in the Second Floor Board Room, **Gateway Center**, 54 Meadow Street, New Haven, CT; unless otherwise indicated.



NEW HAVEN PUBLIC SCHOOLS

Amended
FOOD SERVICE TASK FORCE MEETINGS
13 Month Calendar for 2020 - 2021

January 8, 2020
February 12, 2020
March 11, 2020
April 8, 2020
May 13, 2020
June 10, 2020
July 8, 2020
August 12, 2020
September 9, 2020
October 14, 2020
November 12, 2020* (Thursday)
December 9, 2020
January 13, 2021

Food Service Task Force meetings are held the second Wednesday of the month at **5:00 p.m.** in the Second Floor Board Room, **Gateway Center**, 54 Meadow Street, New Haven, CT; unless otherwise indicated (*).



NEW HAVEN PUBLIC SCHOOLS

Amended
HEAD START SUBCOMMITTEE MEETINGS
13 Month Calendar for 2020 - 2021

January 16, 2020
February 20, 2020
March 19, 2020
April 23, 2020*
May 21, 2020
June 18, 2020
July 16, 2020
August 20, 2020
September 17, 2020
October 15, 2020
November 19, 2020
December 17, 2020
January 21, 2021

Head Start Subcommittee meetings are held the third Thursday of the month at **5:00 p.m.** in the Third Floor Conference Room B, **Gateway Center**, 54 Meadow Street, New Haven, CT; unless otherwise indicated (*).



NEW HAVEN PUBLIC SCHOOLS

NEW HAVEN BOARD OF EDUCATION

Finance & Operations Committee

Resolution for Approval

Recommendation for facility use of 130 Orchard Street, New Haven, CT

The Board of Education approves the use of space at 130 Orchard Street (Strong School) for the school district's Science Kit Refurbishment, Storage and Distribution Center, from January 27, 2020 through June 30, 2020. The classroom space to be used cannot be significantly modified from classroom usage.

The administration will present to the board a proposal for use of surplus and warehoused space for board review and eventual approval by April 2020.

Head Start Budget Justification Narrative

Expense	Quantity	Total	Comments:
Transportation			
Car Seats	40	\$6,000.00	
Bus tracking		\$25,000.00	Monitoring system for students transported by Head Start
Technology			
Laptops: Satellites	10	\$11,000.00	
iPads	10	\$3,000.00	
Desktop Computer	7	\$6,000.00	
Printers	5	\$5,000.00	
Smart Boards for Satellite Classrooms	9	\$63,000.00	Smart Boards
Health and Safety			
Health Order	0	\$6,000.00	
Nurses administrative supplies		\$9,000.00	
Second Step: Social Emotional Curriculum	32	\$15,000.00	
Site Support			
Jepson School, Lincoln-Bassett School, Martinez School and Fair Haven School		\$7,000.00	Teaching supplies
Truman School		\$3,000.00	field trips and literacy resource center
Dr.Mayo	0	\$22,000.00	Field trips, classroom supplies, play materials
Training and Technical Assistance			
Training and Technical Assistance		\$14,874.00	
Other			
Recruitment/Advertising/Outreach/Attendance		\$50,000.00	
District Play Based Learning		\$15,000.00	
Parent and Family Development		\$56,574.00	
Play Materials		\$5,000.00	
Transition: Transition into Head Start Pre-K to Kindergarten		\$10,000.00	
Outreach Giveaways	0	\$3,000.00	
Administrative Office /Satellite Supplies		\$13,000.00	
Travel		\$50,000.00	
Professional Development/Education		\$50,000	Opportunities for part-time employees to complete the Para Pro

		Certification as well as continuing education opportunities and professional development \$448,448.00
--	--	--

The New Haven Public Schools (NHPS) is applying to carryover \$448,448. in federal funding from the grant number 01CH010905-02-00 from fiscal year 2018-2019 to fiscal year 2019-2020. As outlined in the narrative, this funding will be used to support Head Start-specific programming provided directly by the school district. Funds have been allocated appropriately and are split between operational, supplies and professional development. The budget has been designed to support NHPS’s key programmatic initiatives.

Transportation:

\$31,000.00 has been allocated to purchase car seats and a bus tracking system. The car seats are required by Head Start Performance Standard 1303.71. These seats will be used as replacement seats as well as placed on an additional bus that will be utilized when break downs occur. Currently, First Student does not have a replacement bus for Head Start with car seats. The tracking system will be used to ensure the safety of our students and keep parents up to date with bus transportation.

Technology:

The New Haven Head Start Satellite classrooms have not received the technology updates that occurred for the Dr. Mayo School when it was opened. Our budget earmarks \$88,000.00 dollars to cover various technological needs of the satellites such as teacher laptops, desktop computers for student use, iPad for family service workers, smart boards for classrooms as well as printers.

Health and Safety:

As Head Start respects the development of the whole child \$15,000.00 was allocated for the purchase of Health materials to support the nursing staff in tending to our students’ needs as well as completing the Head Start mandated screenings as described in Head Start Performance Standards 1302.42: Child health status and care. The amount of \$15,000.00 will be used to purchase the Second Step: Social Emotional Curriculum that will support the Head Start Performance Standard 1302.45: Child mental health and social and emotional well-being.

Site Support: The budget includes \$32,000.00 for site leaders to use as they deem needed in support of curriculum and instruction. The funds are allocated for supportive classroom materials, out of school field trips as well as in school field trips in accordance with the Head Start Performance Standard: 1302.31 teaching and the learning environment.

District Play-based Learning: As a member of the New Haven Public Schools, our teachers and students will be participating in the district wide play-based learning initiative. Our investment in this initiative will guarantee the participation of the Dr. Mayo teaching staff as well as the satellites’ teaching staff. Head Start Performance Standards: 1302.31 Teaching and the learning environment 1302.32 Curricula covers this area of the budget.

Recruitment/Outreach/Attendance: Actively recruiting and enrolling students is paramount to the success of the New Haven Head Start Program. The district’s relocation of the Head Start ERSEA department to the Gateway Building has impacted the enrollment of our students. This

change in location has necessitated a change in our recruitment and enrollment process. Attendance for both children and staff has historically been an area of difficulty. The use of these funds will also be to develop attendance initiative. Head Start Performance Standards: 1302.13

Recruitment of children 1302.16 Attendance

- Billboard Advertisement
- Community Bus Recruitment Promotion
- Development of Video for Promotion and Recruitment
- Development of Video for Parent on boarding to the Head Start Program: reviews expectations for parent participation and student attendance
- Student Attendance Incentives
- Policy Council Recruitment

Travel and Conferences: The National Head Start Association, the Regional Head Start Association and the State Head Start Association all offer conferences throughout the year to strengthen all components of the program. This year it is our goal to send members from all areas of the New Haven Head Start Program to represent, to learn and to share their new knowledge. We have budgeted to send ten members of the New Haven Public Schools Program to the National Conference in Arizona including policy council members, teachers, teacher assistants and Family Service Workers. The program will also send a delegation to the state conference in Connecticut. This line item is in support of the Head Start Performance Standards: 1302.34 Parent and family engagement in education and child development services, 1302.31 teaching and the learning environment and 1302.32 Curricula.

Professional Development/Continuing Education: Our children's educational experience is only as good as the teaching staff that guides them through their learning experience. It is the goal of New Haven Head Start to cultivate the talented teaching staff by offering enrollment in the Para-Pro Program for part-time employees that would like to develop their knowledge. We will also offer the opportunity for our satellite teachers that have yet to take a class towards the completion of certification requirements.

- Para-Pro Training for Part-time staff and parents
- Continuing Education for all Staff in their identified work areas
- Professional Development Opportunities based on goal setting

Transitions: As research has shown a positive transition from preschool to kindergarten plays a role in a student's future learning and achievement. The funds in this line up will be used to help educate our Head Start parents about the transition that will take place. Our children will also receive a "Ready for Kindergarten" shirt as well as a backpack of kindergarten learning supplies. Head Start Performance Standard 1302.71: Transitions from Head Start to Kindergarten targets this area. Our Head Start will also institute a "Welcome to Head Start" program that will familiarize families and children to the program and supply them with the materials necessary for a successful school year.

- Transition to Head Start Back Pack: Pre-kindergarten
- Transition to Kindergarten: Field Trips to NHPS Kindergartens, Back Pack with Kindergarten Supplies
- "Typical Kindergarten Day" Video for parents and community members
- T-shirt Highlighting Students moving on to Kindergarten

Parent and Family Development: In accordance with the Head Start philosophy of being a program that is supportive of both children and families, the carryover budget includes \$40,000.00 for parent and family development. (Performance Standard 1302.34 Parent and family engagement in education and child development services.

- Job training
- Training in Parent Advocacy Child Development and Parenting Training

DRAFT

Elizabeth Gaffney
Head Start Director



P: (475) 220-1467
F: (203) 946-2297

Approval of Submission of Head Start Grantee Carryover Funds

City of New Haven in New Haven County, Connecticut

We, the members of New Haven Public Schools Board of Education, enthusiastically support and approve the submission of this application of Carryover Funds for the City of New Haven in New Haven County requesting a budget of \$433,574 for operations and \$14,874 for training and technical assistance for the Head Start Program period of July 1, 2019 through June 30, 2020.

New Haven Public Schools, Board President

Date

CLIFTON BUSH Jr.

Add a Memory

Share This Page

SERVICES

St Matthews Unison Free Will

400 Dixwell Ave
New Haven, CT 06511

- Send Flowers
- Email Service Info
- Website | Map

See Services Detail

RESOURCES

- More Obituaries for CLIFTON BUSH
- Looking for an obituary for a different person with this name?
- BUSH Records (15)



Clifton Bush Jr., of New Haven, entered into eternal life on Sunday September 3, 2017 at his home. Born in Greensboro, NC., the beloved son of Gaytha (Moye) Bush and the late Clifton Bush Sr. Cherished father of Andre (Diane) Thomas, Malaika Chisholm, Kimya Bush, Bakari Bush, Shomari Bush, and Nia Moore-Bush. Loving brother of Delzora Bush, Curtis (Debra) Bush, and Wayne (Trina) Bush. Also survived by 7 grandchildren and 5 great grandchildren. Predeceased by one son Pierre Bush, one sister Dolores Bush, and one brother Gary Bush. Clifton was a college professor at Springfield College for 26 years, where he taught numerous courses mainly focused on African American History, African History, and Sociology. He was also an adjunct college professor at Southern Connecticut State University and University of New Haven. A celebration of Clifton's life will be held on Tuesday September 12, 2017 in St. Matthew's UFW Baptist Church, 400 Dixwell Ave. New Haven at 11:15am. Viewing in Church from 10-11am. Interment will be at Beaverdale Memorial Park. Condolences may be expressed at colonialfunerals.com.

Published in The New Haven Register on Sept. 10, 2017

[Read Less](#) | [Print](#) | [Listen to Obituary](#)

SHOW YOUR SYMPA



Send a beautiful bouquet to th and let them know they're Ir thoughts.

Order Now

Order by Phone (855) 329-1

REMEMBER

Share memories or express condolences below.

[View All](#)

Add a memory or condolence to the guest book

"Gone but not forgotten. A friend forever. We had some..."
-Robert Sheeley

"I have just heard about the passing of my friend and..."

ADD MESSAGE

[View All Messages](#) 36

ADD PHOTOS

ADD VIDEOS

ACDelco

AN AC COMPRESSOR

You won't sweat

CERTAIN FROM THE STAR

SHOP NOW

Funeral Etiquette

Expert advice do and say w someone die

ADVERTISING



VERDIN

BELLS & CLOCKS
SINCE 1842

RENDERING PREPARED FOR:
Foundation for New Haven Parks, Inc.
New Haven CT
Model # J-Gim - School Location
April 23, 2019

This photo-rendering is an approximation of the Verdin clock on your site and is not intended to be used as final artwork for header text and dial art.

PROPERTY OF THE VERDIN COMPANY
Cincinnati, OH 800-343-9488 verdin.com

HOWARD REPLICA II

FONT: TIFFANY
 FONT SIZE: 1 3/4"h
 COLOR: "GOLD"

FONT: TIFFANY
 FONT SIZE: 1"h
 COLOR: "BLACK"

ROMAN DIAL—"BLACK"
 SPADE HANDS "BLACK"
 W/ "WHITE" BAL. RODS

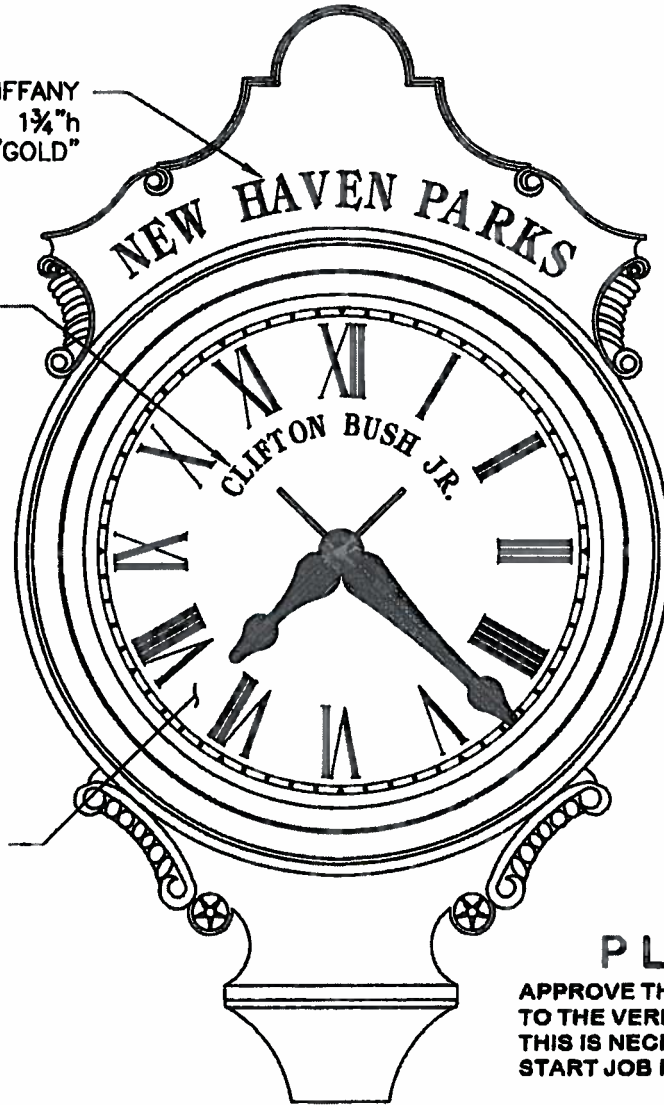

PLEASE

APPROVE THIS COPY AND RETURN
 TO THE VERDIN COMPANY.
 THIS IS NECESSARY IN ORDER TO
 START JOB FABRICATION.

Sign _____

Date _____

MODEL No. 4Z

NOTES:

1. JOB No. 192229
 JAMES HILLHOUSE HIGH SCHOOL
 NEW HAVEN, CT
2. POSTCLOCK: 4Z
 2.a. COLOR: VERDIN "GREEN"
 w/"GOLD" ACCENT



VERDIN DESIGN GROUP

THE VERDIN COMPANY
 CORPORATE HEADQUARTERS
 444 READING ROAD
 CINCINNATI, OHIO 45202
 1-800-643-0488
 sales@verdin.com
 www.verdin.com

3900 KELLOGG AVENUE
 CINCINNATI, OHIO 45226
 (800) 217-2258
 MAIN FAX (888) 389-5019
 clocks@verdin.com

THIS DESIGN CONCEPT IS THE EXCLUSIVE PROPERTY OF THE
 VERDIN COMPANY, AND MAY NOT BE COPIED, REPRODUCED,
 MANUFACTURED, MARKETED, OR SOLD IN WHOLE OR ANY
 PART THEREOF WITHOUT THE EXPRESS WRITTEN CONSENT OF
 THE VERDIN COMPANY. 444 READING ROAD, CINCINNATI, OHIO.

SCALE: 1/2" = 1'-0" DRAWN BY: ETS

DRAWING NUMBER:
 19 CLK/
 A 5055

DATE: AUG 1, '19 REVISED:

CLIFTON T
BUSH, JR.

1/2/27/1944

9/3/2017

IN RECOGNITION
AND GRATITUDE
FOR YOUR
LIFETIME
DEDICATION TO
THE YOUTH OF
NEW HAVEN.
YOUR HARD
WORK, KINDNESS
AND GENEROSITY
WILL FOREVER BE
REMEMBERED
AND
APPRECIATED.

CLIFF WISHES ALL
A LIFETIME OF
LOVE, JOY &
LAUGHTER.

BOARD OF PARK
COMMISSIONERS
NEW HAVEN
PARKS,
RECREATION
AND TREES

← AFFECTIONATELY
KNOWN AS
"SQUIRREL"



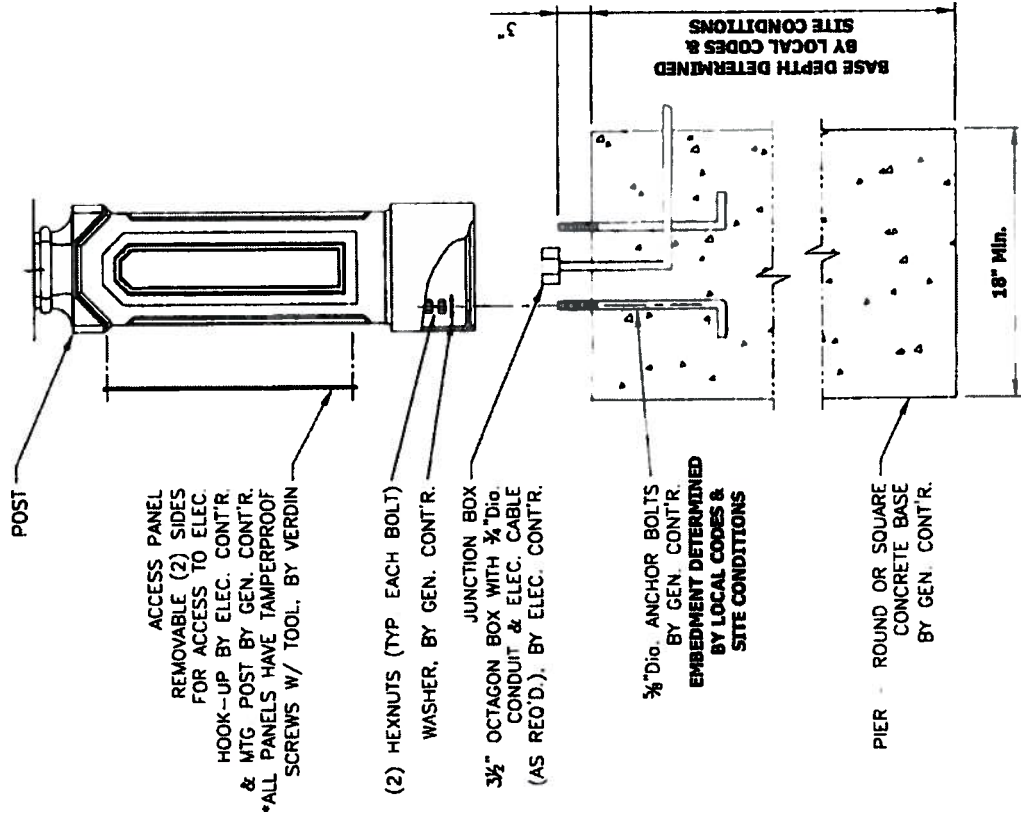

1 Elevation View
3/4"=1'-0"

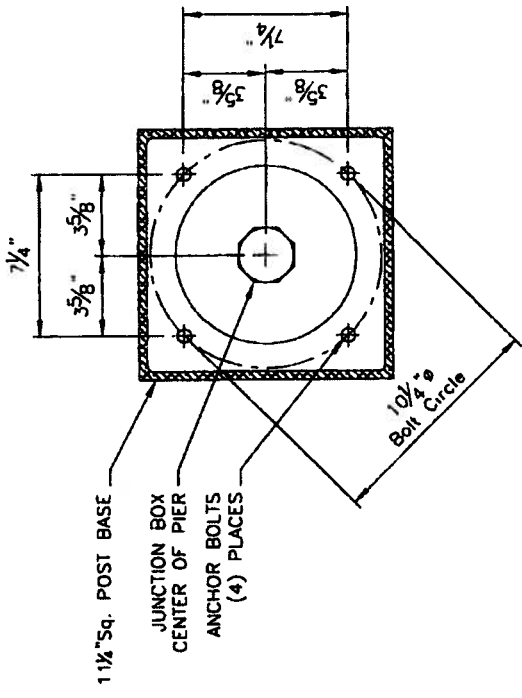

2 Plan View
1-1/2"=1'-0"

NOTE:
This drawing can be used for the following Post Clock(s)
- 4MST2 / 4SZ / 4Z

VERDIN 	The Verdin Company Corporate Headquarters 444 Reading Road Cincinnati, Ohio 45208 513-941-4010 1-800-848-0868 Fax 513-941-1666	Rail & Conflux Manufacturing Facility 5081 Ruckman Avenue Cincinnati, Ohio 45208 Cincinnati, Ohio 45208 Fax 513-981-8736 Design Chinese Division
	The "Howard Replica II" Post (Cost Aluminum) Anchoring Detail	
SCALE: As Noted	DRAWN BY: SRP/LAT	DRAWING NUMBER: 05 CLK/ A 4421 E
DATE:	REVISED: Dec. 7, '07	

THIS DRAWING IS THE PROPERTY OF THE VERDIN COMPANY AND IS ISSUED TO THE RECIPIENT WITH THE UNDERSTANDING THAT IT SHALL NOT BE COPIED, DUPLICATED, PASSED ON TO UNAUTHORIZED PARTIES, NOR USED FOR ANY PURPOSE OTHER THAN THAT FOR WHICH IT IS SPECIFICALLY FURNISHED, EXCEPT WITH THE VERDIN COMPANY WRITTEN PERMISSION.

AVAILABLE LETTERING STYLES FOR LOGO HEADERS

CALLIGRAPH 1234567890

ENCHANTED 1234567890

Old English 1234567890

BENQUIAT 1234567890

HELVETICA 1234567890

SOUVENIR 1234567890

FLARE SERIF 1234567890

James Bold 1234567890

PARISIAN 1234567890

CASLON 1234567890

TIFFANY 1234567890

BERNHARD 1234567890

Dauphin 1234567890

ENVIRO 1234567890

GOUDY 1234567890

Lydian 1234567890

Marriage 1234567890

SAXON 1234567890

VARIANT 1234567890

WOOD 1234567890

HEBREW

COPPERPLATE GOTHIC 1234567890

ROME EXTRA BOLD 1234567890

CORRIGAN LIGHT 1234567890

NEW BASKERVILLE 1234567890

MELANITE BOLD 1234567890

ZAPP CHANCERY 1234567890

Richelo Broad pen 1234567890

Banner English 1234567890

TIMES ROMAN 1234567890

UNIVERSITY ROMAN 1234567890

GARAMOND 1234567890

CUSTOM LETTERING AVAILABLE UPON REQUEST

	VERDIN DESIGN GROUP 444 Reading Road, Cincinnati, Ohio 45208 513-841-4010 1-800-549-0199 FAX 513-841-1868	
<small>THIS DESIGN CONCEPT IS THE EXCLUSIVE PROPERTY OF THE VERDIN COMPANY, AND MAY NOT BE COPIED, REPRODUCED, MANUFACTURED, MARKETED, OR SOLD IN WHOLE OR ANY PART THEREOF WITHOUT THE EXPRESS WRITTEN CONSENT OF THE VERDIN COMPANY, 444 READING ROAD, CINCINNATI, OHIO.</small>		
SCALE: NONE	DRAWN BY: GLFJ	DRAWING NUMBER:
DATE: 7/15/95	REVISED: 8/13/99	95 CLK/ A 1704-20

~7

STANDARD STREET CLOCK DIAL FACES

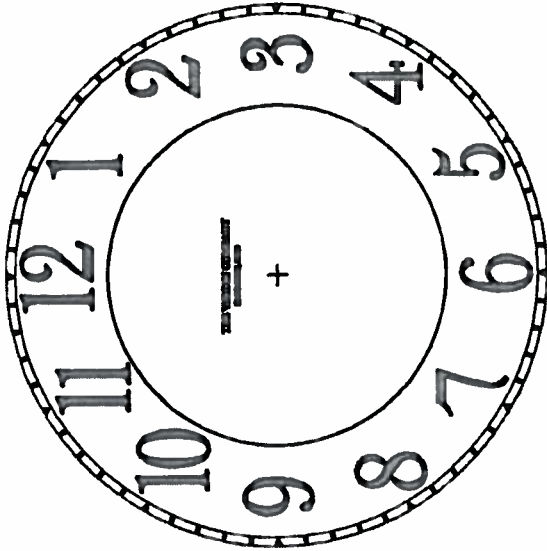

ARABIC

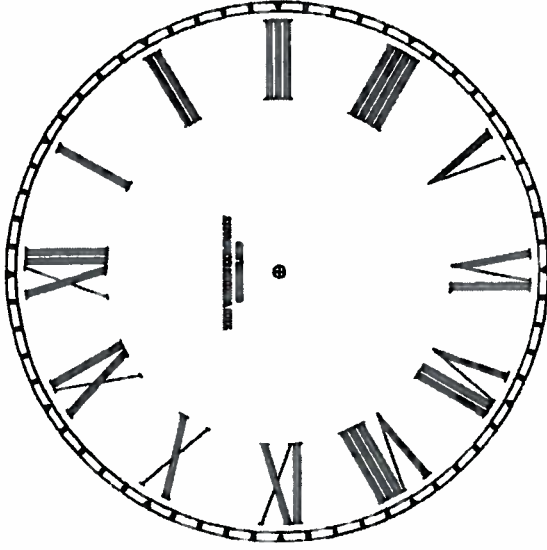

ROMAN

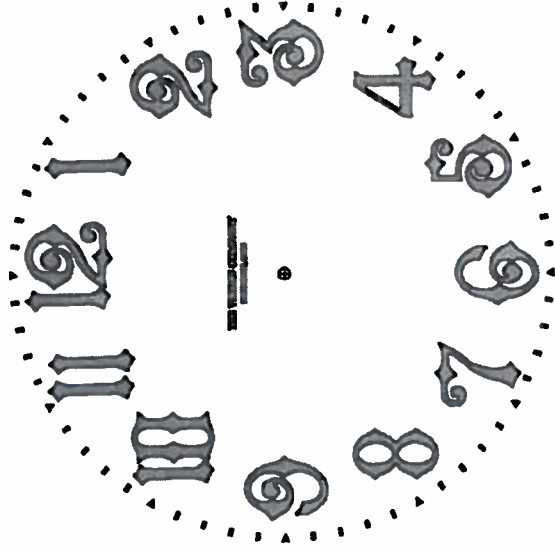

VICTORIAN

SELECT ONE DIAL STYLE

VERDIN DESIGN GROUP

444 Bonding Blvd. Cincinnati, Ohio 45208
 513-951-4010 1-800-848-0488 FAX 513-951-1898

THIS DESIGN CONCEPT IS THE EXCLUSIVE PROPERTY OF THE VERDIN COMPANY, AND MAY NOT BE COPIED, REPRODUCED, MANUFACTURED, MARKETED, OR SOLD IN WHOLE OR IN PART WITHOUT THE EXPRESS WRITTEN PERMISSION OF THE VERDIN COMPANY. 444 BONDING ROAD, CINCINNATI, OHIO.

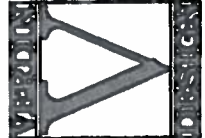

SCALE: NST DRAWN BY: HEM DRAWING NUMBER: 06 CLK/A 1704-26
 DATE 04/17/06 REVISED:

Post Clock Fundraising



Bronze Recognition Plaques with sponsors names are an easy way to raise all or more that is required to purchase a new Verdin clock.

100 names on the clock at the \$250 dollar Level will raise about \$21,000

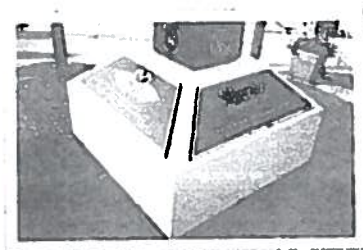
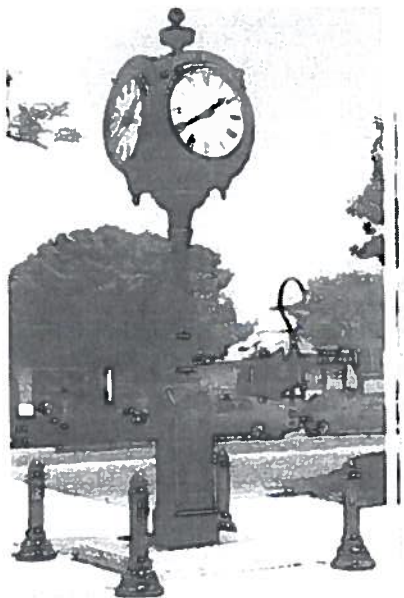

BELLS & CLOCKS
SINCE 1842

Model: MCC3

Master Clock Controller

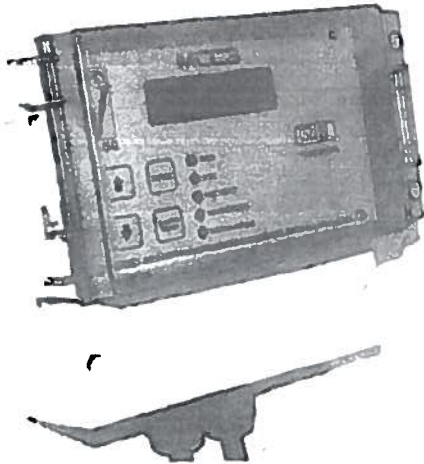

The MCC3 is designed to provide many years of worry free automatic control of your total clock system. The Verdin MCC3 is a microprocessor based clock control system comprising a high precision crystal-controlled time base, programming keypad, LCD display, and all the required interface ports. This highly flexible clock control device is capable of overseeing the complete operation of a tower clock or a street clock system. It has been designed to interface with all Verdin peripheral elements.

Technical Specifications

Power Supply

The MCC3 operates on standard 120VAC, 50-60 Hz. single phase power. It is fused for a total of six amps (nominal). The MCC3 is supplied with a ten year internal battery back-up for maintaining time and program memory during power failure.

Time Base

Superior accuracy is assured through the use of a temperature-compensated crystal-controlled time base operating at a frequency of 32.768 kHz. Accuracy shall be within +/- 5 seconds per month at a normal operating temperature of 20° C +/- 20 (Maximum variation of +/- 20 seconds per month at extremes of operating range, -40° C and 85° C.)



BELLS & CLOCKS
SINCE 1842

Tower/Street Clock Control

The MCC3 maintains accurate present time in accordance with the internal crystal controlled time base. In addition a separate register is maintained which constitutes an internal "pilot clock" for the tower clock(s) or street clocks being controlled. In case of power failure, the internal time base and actual time keeping are maintained via the back-up batteries.

During times of power failure, when external movements (tower/street clocks) are stopped, the internal "pilot clock" is also held at the time when power failure began. When power is restored this register is examined, and automatic correction of the Tower/street clock is made.

The MCC3 is cable of controlling either A/B impulse style timepieces or synchronous timepieces. Selection between either impulse or synchronous mode is made via a jumper setting. LED's on MCC3's front panel will indicate its operational state.

Daylight Saving Time (DST)

The MCC3 is provided with a fully-automatic Daylight Saving Time set function. This function maintains the proper time on both the MCC3 and the Tower/Street clock throughout the time change period. Front panel user settings allow the unit to be set in the current USA adopted system or a custom user defined system.

Hour Strike and Light Function

The MCC3 provides two time programmable external outputs intended to drive an external lighting system and/or the striker of an external hour strike bell. Front panel user settings allow the operation times for each output to be defined.

Communications

The MCC3 provides two external communication ports. The first is designed to interface with Verdin's optional GPS unit and the second provides an external RS-232 interface port. Through the MCC3 RS-232 port the time may be read or set, the hand position may be read, the light relay activated or deactivated, the hour strike relay activated or deactivated. In addition the RS-232 port provides for a seamless interface to Verdin's optional electronic carillon and chiming equipment. All functions other than the remote light and hour strike are accessible via the keypad.

THE VERDIN COMPANY BUILDERS OF FINE BELLS & CLOCKS SINCE 1842

Corporate Headquarters: 444 Reading Road - Cincinnati, OH 45202 - P: 800-543-0488 F: 513-241-1855 - www.verdin.com

HOWARD REPLICA II

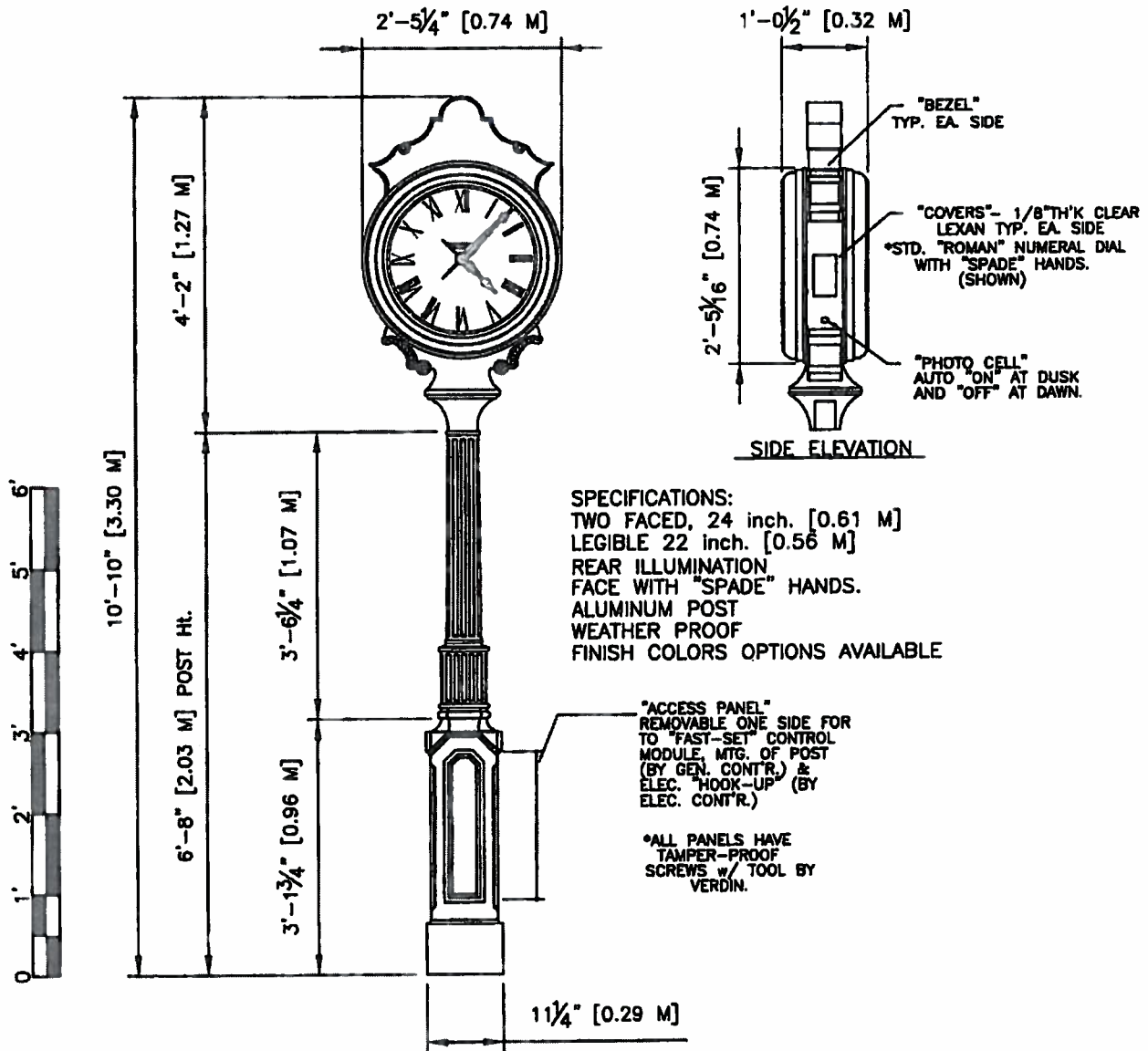

MODEL No. 4Z
Scale: $\frac{1}{2}$ " = 1' 0"



VERDIN DESIGN GROUP

THE VERDIN COMPANY
CORPORATE HEADQUARTERS
444 READING ROAD
CINCINNATI, OHIO 45202
1-800-643-0488
sales@verdin.com
www.verdin.com

THIS DESIGN CONCEPT IS THE EXCLUSIVE PROPERTY OF THE VERDIN COMPANY, AND MAY NOT BE COPIED, REPRODUCED, MANUFACTURED, MARKETED, OR SOLD IN WHOLE OR ANY PART THEREOF WITHOUT THE EXPRESS WRITTEN CONSENT OF THE VERDIN COMPANY, 444 READING ROAD, CINCINNATI, OHIO.

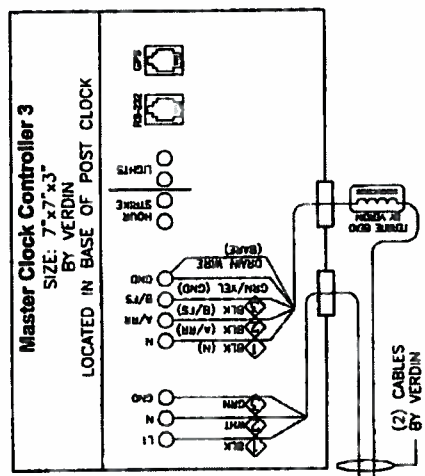
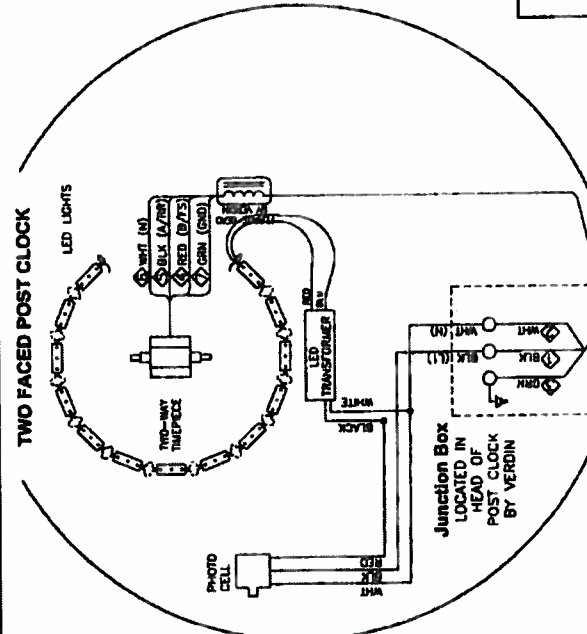

SERVICE
 120 VAC
 60 HZ
 20 AMP
 SINGLE PHASE
DEDICATED

(2) No. 12 WIRES &
 (1) No. 12 WIRE [GND]
 RUN IN CONDUIT TO POST CLOCK
 BY ELEC. CONTR.

THIS DRAWING IS THE PROPERTY OF THE VERDIN COMPANY AND IS ISSUED TO THE RECIPIENT WITH THE UNDERSTANDING THAT IT SHALL NOT BE COPIED, DUPLICATED, PASSED ON TO UNAUTHORIZED PARTIES, NOR USED FOR ANY PURPOSE OTHER THAN THAT FOR WHICH IT IS SPECIFICALLY FURNISHED, EXCEPT WITH THE VERDIN COMPANY WRITTEN PERMISSION.

NOTES:

A) All electrical equipment is to be earth grounded.

VERDIN	A	SINCE 1948
	<p>The Verdin Company Corporate Headquarters 844 Sandberg Blvd Chardon, Ohio 44024 216-281-4010 1-800-948-0888 Fax 216-281-1866</p> <p>Manufacturing Facility 8900 Exchange Avenue Chardon, Ohio 44026 Fax 216-281-1866</p>	
<p>This drawing can be used for the following Post Clocks - Models 4Z</p>		
<p>Electrical Wiring Diagram for a (2) Faced Post Clock (LED Lights) with a MCC3</p>		
SCALE: None	DRAWN BY: GLFJ	DRAWING NUMBER: 10 ELEC/
DATE: Mar. 1, '11	REVISED: Mar. 1, '12	B 4575 D

Golf Course & Country Club
Clock Installations by Verdin



Golf Course & Country Club Installations by Verdin

Improve pace of play with a course clock by Verdin and enhance the beauty of your course or club. Establish a distinct identity, accent a favorite gathering spot, commemorate important anniversaries, honor the contributions of a key member. Verdin course clocks are the finest in the industry and a practical investment for your site.



Princeton, NC

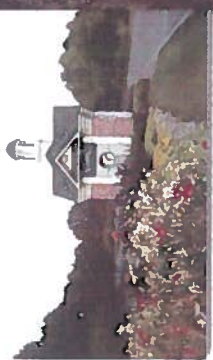

Captain's Club Golf Club
Grand Blanc, MI

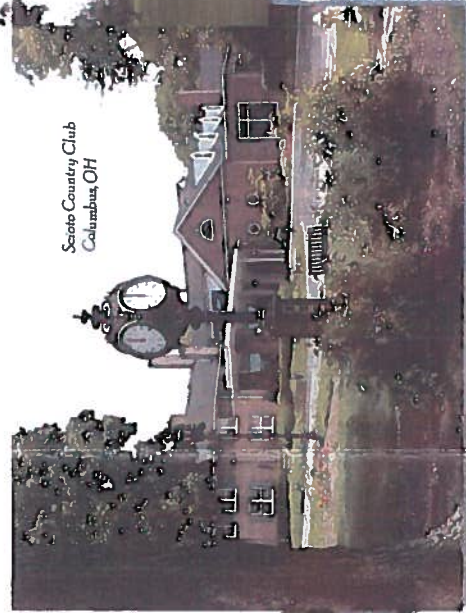

Scoto Country Club
Columbus, OH

Fl. Lauderdale Country Club
Fl. Lauderdale, FL

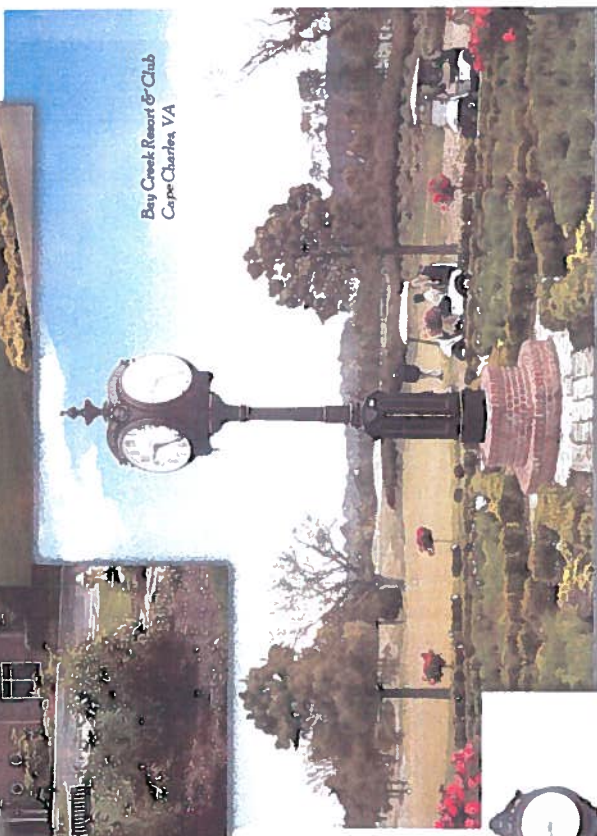

Bay Creek Resort & Club
Cape Charles, VA



Dallas Country Club
Dallas, TX

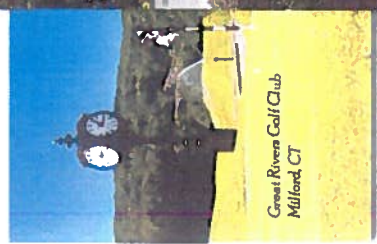

Great Rivers Golf Club
Millford, CT

- Each clock custom built
- Entire clock U/L approved
- Superior backlit dials
- Weatherproof
- Custom headers on course clocks
- Logo or medallion dials
- Custom colors available
- Installation & maintenance by Verdin technicians

The Verdin Company
444 Reading Road
Cincinnati, OH 45202
800-543-0488
www.verdin.com

New Construction

Construction in Physical Facilities

Naming of Facility

It shall be the prerogative of the Board of Education to establish the need and appropriateness for naming any school unit, which includes all outdoor and indoor facilities of the school.

1. It shall be the general policy to name schools and school facilities for persons who have attained prominence locally and nationally, or in the fields of education, science, art, statesmanship, political science, or military achievement; early pioneers of the community or the State of Connecticut; outstanding presidents of the United States of America; or geographical landmarks.
2. The general procedure for selecting a name for a school shall be as follows:
 - a. The Board shall appoint a committee comprised of two representatives of the Board of Education chosen by its President; two representatives of the Citywide School Construction Committee chosen by its Chair; one teacher/administrator representative appointed by the Board of Education; and one PTA/PTO representative appointed by the Board of Education.
 - b. The school-naming committee shall then present a recommended name to the superintendent who will forward it to the Board.
 - c. The Board shall then accept or reject said recommendation from the committee.

New Construction

Naming Facilities

The naming of school buildings, major portions of buildings, or school grounds is the responsibility of the Board of Education. In fulfilling this responsibility, the Board will make every effort to respect community preferences. Such names should be clearly identifying, widely known, and recognized.

It is the policy of the Board to name school buildings as close as possible to the time construction begins in order to lessen the confusion about the new schools.

When naming new buildings, major portions of buildings, or school grounds, the Board shall formally identify the need for a naming process for the identified school locations, as well as criteria it wishes to be considered in the process.

When naming a school building, major portions of school buildings, or school grounds the Board shall direct the Superintendent to establish a committee, subject to Board approval, comprised of the Superintendent or designee, the building Principal, faculty member, parents, community members, and, if appropriate, students to consider name recommendations for consideration by the Board. Opportunities for public input must be made available prior to the committee's recommendation to the Board. Such opportunities for public input must be publicly announced in newspapers and on the District website.

When naming new buildings, the committee shall have representation by the community members that is representative of the entire school district. The committee shall propose a list of names to the school board of not more than five (5) names for Board consideration.

If a major portion of a school building or school grounds (media center, auditorium gymnasium, field, etc.) is proposed to be named after an individual, that person shall have attained local or national prominence via significant contributions in any field of endeavor. Such contributions or the significance of their place in history shall be clearly established beyond the generation of the contribution. Individuals so recognized shall no longer be active in his/her career. Further, the individual for whom a portion of a school building or school grounds is to be named must be shown to have broad-based, long-term impact to the school district community.

Collections of works, memorials, or other major gifts to the school district may be acknowledged and named by individual schools, subject to the district's policy and procedures for accepting donations. Prior to accepting such donations and naming, a plan for maintenance and upkeep must be identified and presented to the school Board.

The Board retains the right to make final determination in the naming of buildings, major portions of school buildings, or school grounds. This policy notwithstanding, it is the intent of the Board that naming of portions of the building and school grounds occur infrequently and on a limited based.

Policy adopted: